



UNIVERSITY OF CAMBRIDGE INTERNATIONAL EXAMINATIONS
International General Certificate of Secondary Education

CANDIDATE
NAME

CENTRE
NUMBER

--	--	--	--	--

CANDIDATE
NUMBER

--	--	--	--



MATHEMATICS

0580/03, 0581/03

Paper 3 (Core)

May/June 2009

2 hours

Candidates answer on the Question Paper.

Additional Materials:

Electronic calculator

Geometrical instruments

Mathematical tables (optional)

Tracing paper (optional)

READ THESE INSTRUCTIONS FIRST

Write your Centre number, candidate number and name on all the work you hand in.

Write in dark blue or black pen.

You may use a soft pencil for any diagrams or graphs.

Do not use staples, paper clips, highlighters, glue or correction fluid.

DO NOT WRITE ON ANY BARCODES.

Answer **all** questions.

If working is needed for any question it must be shown below that question.

Electronic calculators should be used.

If the degree of accuracy is not specified in the question, and if the answer is not exact, give the answer to three significant figures. Give answers in degrees to one decimal place.

For π , use either your calculator value or 3.142.

At the end of the examination, fasten all your work securely together.

The number of marks is given in brackets [] at the end of each question or part question.

The total of the marks for this paper is 104.

For Examiner's Use

--

This document consists of **16** printed pages.



- 1 (a) Roberto owns 6000 square metres of land.
He divides it between himself and his two children, Stefano and Tania, in the ratio

$$\text{Roberto} : \text{Stefano} : \text{Tania} = 7 : 5 : 3.$$

- (i) Show that Roberto now has 2800 square metres of land.
Answer(a)(i)

[2]

- (ii) Calculate the area of land that Stefano and Tania each have.

Answer(a)(ii) Stefano m²

Tania m² [2]

- (b) Roberto receives a rent of \$1.40 per month for each square metre of his land.

- (i) Calculate the rent he receives in **one year** from his 2800 square metres of land.

Answer(b)(i) \$ [2]

- (ii) Roberto uses $\frac{3}{5}$ of this amount to buy more land.

Calculate the amount that he uses to buy more land.

Answer(b)(ii) \$ [2]

- (c) Stefano builds a house on his land.
He borrows \$5000 from a bank at 8% per year **simple** interest.
Find the total amount of interest he will have paid at the end of 3 years.

For
Examiner's
Use

Answer(c) \$ [2]

- (d) Tania sells her land for \$12 000.
She invests the money for 3 years at 6% per year **compound** interest.
Calculate the total amount of money she will have at the end of the 3 years.
Give your answer to the nearest dollar.

Answer(d) \$ [4]

- 2 The diagram represents a fairground wheel with centre O , and diameter 30 metres. Point D is vertically below point A , and the line EDB is horizontal. $ED = 20$ metres.

For
Examiner's
Use

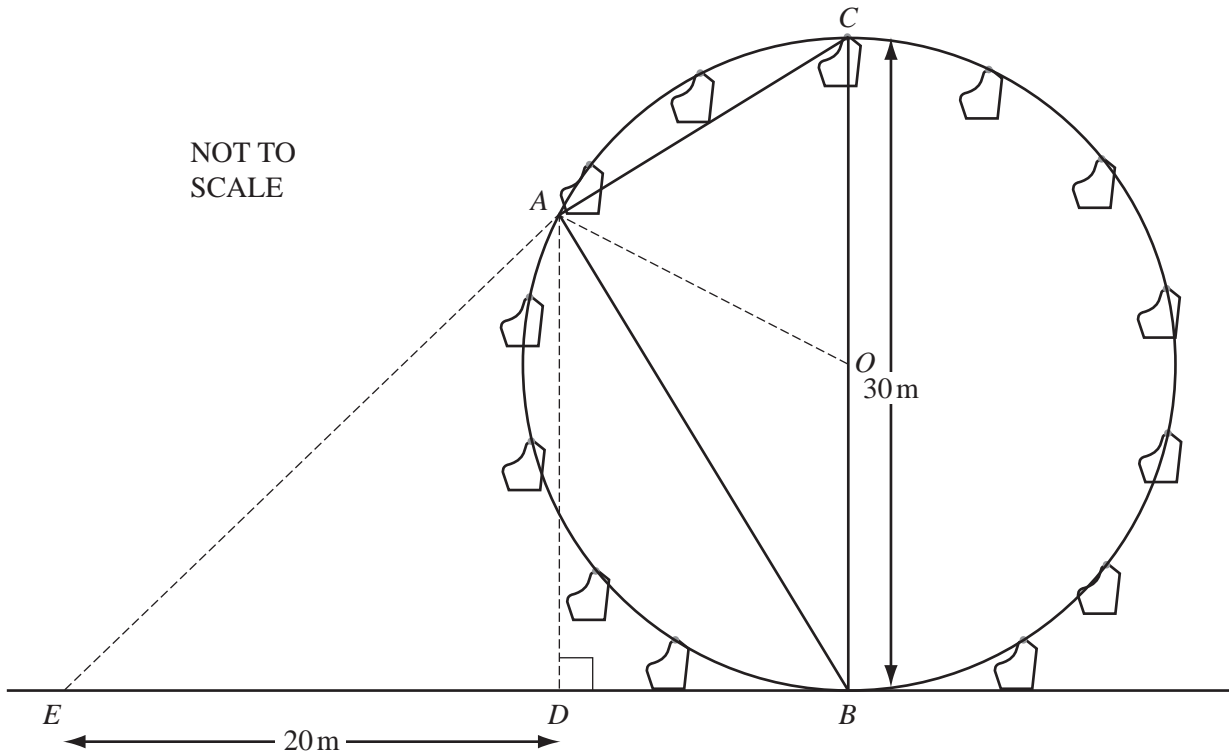

- (a) A seat starts at B and travels one-third of the circumference to A .

Explain why angle AOB equals 120° .

Answer(a)

[1]

- (b) Find the value, in degrees, of

- (i) angle ABO ,

Answer(b)(i) Angle $ABO = \dots\dots\dots$ [1]

- (ii) angle BAC ,

Answer(b)(ii) Angle $BAC = \dots\dots\dots$ [1]

- (iii) angle ABD .

Answer(b)(iii) Angle $ABD = \dots\dots\dots$ [1]

- (c) (i) Use trigonometry in triangle ABC to calculate the distance AB .

For
Examiner's
Use

Answer(c)(i) $AB =$ m [2]

- (ii) Show that $AD = 22.5$ metres.

Answer(c)(ii)

[2]

- (d) Eshe holds her camera at E and takes a photograph of her friend in the seat at A .

Calculate angle AED .

Answer(d) [2]

3 All the times given in this question are the local time in Paris.

Pierre left Paris at 08 00 to go to his office in London.

He travelled 30 kilometres to the airport.

He arrived at 08 30 and his plane left one hour later.

It flew 350 kilometres to London airport and landed at 10 15.

Pierre left London airport at 10 50 and he arrived at his office in London 40 minutes later.

(a) On the grid below, complete the travel graph.

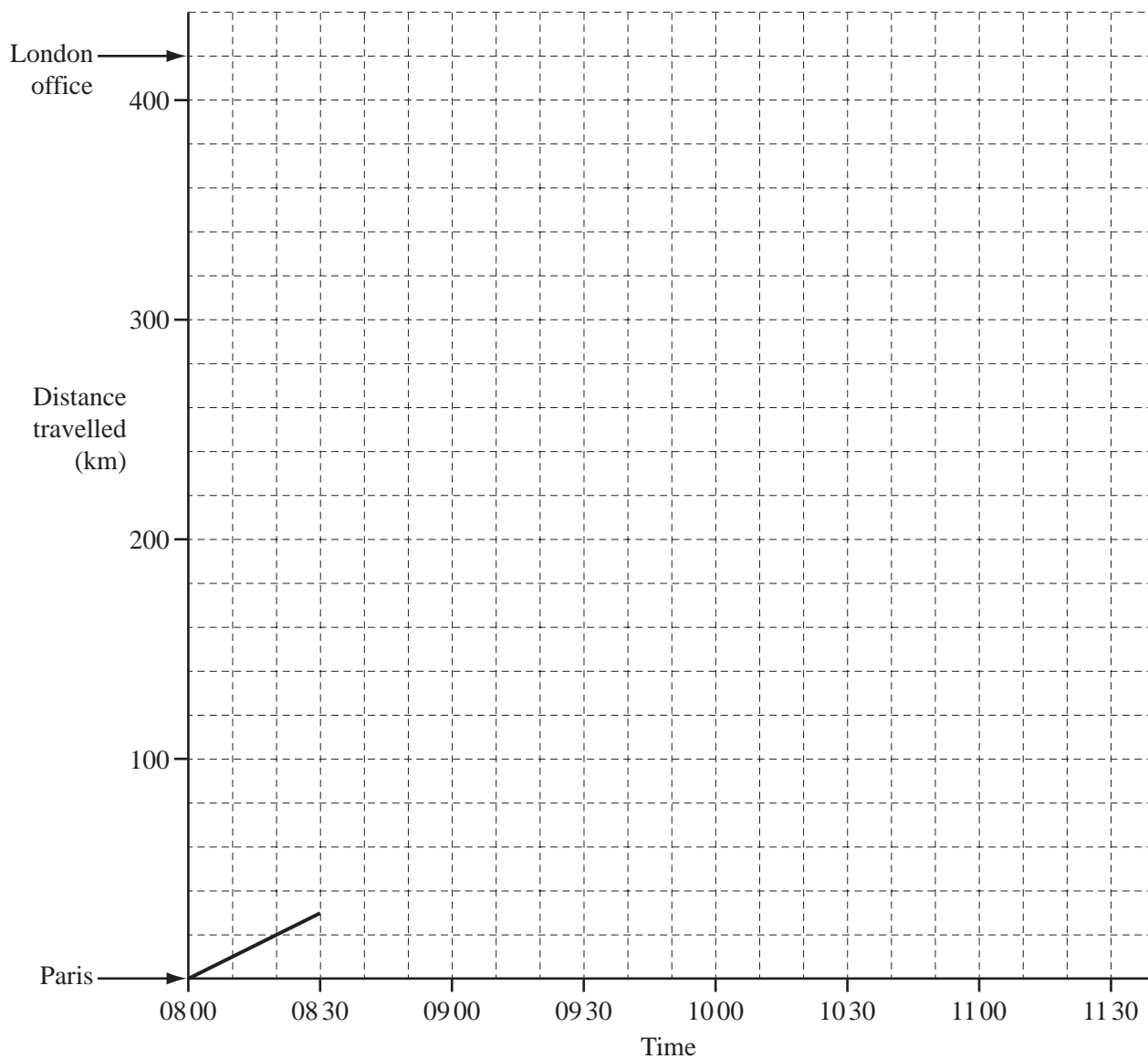

[4]

For
Examiner's
Use

- (b) (i) How long is the flight from Paris to London?
Give your answer in hours.

Answer(b)(i) h [1]

- (ii) Calculate the average speed of the flight, in kilometres/hour.

Answer(b)(ii) km/h [2]

- (c) Pierre's colleague, Annette, travelled from Paris to London by train.
She left at 09 50 and arrived at the London office at 12 45.
Calculate the difference in the times taken by Pierre and Annette for the whole journey.
Give your answer in minutes.

Answer(c) min [3]

For
Examiner's
Use

4 (a) Garcia and Elena are each given x dollars.

(i) Elena spends 4 dollars.

Write down an expression in terms of x for the number of dollars she has now.

Answer(a)(i) \$ [1]

(ii) Garcia doubles his money by working and then is given another 5 dollars.

Write down an expression in terms of x for the number of dollars he has now.

Answer(a)(ii) \$ [1]

(iii) Garcia now has three times as much money as Elena.

Write down an equation in x to show this.

Answer(a)(iii) [1]

(iv) Solve the equation to find the value of x .

Answer(a)(iv) $x =$ [3]

(b) Solve the simultaneous equations

$$\begin{aligned} 3x - 2y &= 3, \\ x + 4y &= 8. \end{aligned}$$

Answer(b) $x =$

$y =$ [3]

For
Examiner's
Use

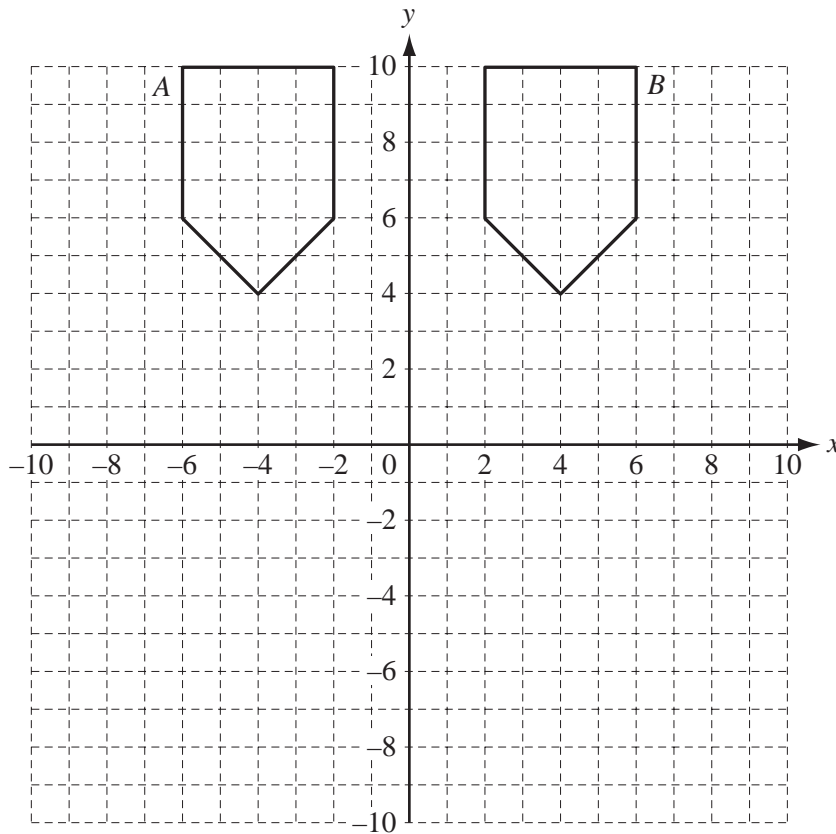

(a) Two different **single** transformations can map shape *A* onto shape *B*.

Describe each transformation fully.

Answer(a)

or [4]

(b) Reflect shape *A* in the *x* axis. Draw the image and label it *C*. [2]

(c) Rotate shape *B* through 90° clockwise about the origin. Draw the image and label it *D*. [2]

(d) Describe fully the **single** transformation which maps shape *C* onto shape *B*.

Answer(d) [3]

(e) Draw the enlargement of shape *A*, centre $(-4, 8)$, with scale factor $\frac{1}{2}$.

Label the image *E*. [2]

6 (a) Write down the name of a polygon with 8 sides.

For
Examiner's
Use

Answer(a) [1]

(b) Find the size of the interior angle of a regular polygon with 8 sides.

Answer(b) [2]

(c) A regular 8-sided polygon, centre O , and side 8 cm, is shown below.
 M is the mid-point of the side AB .

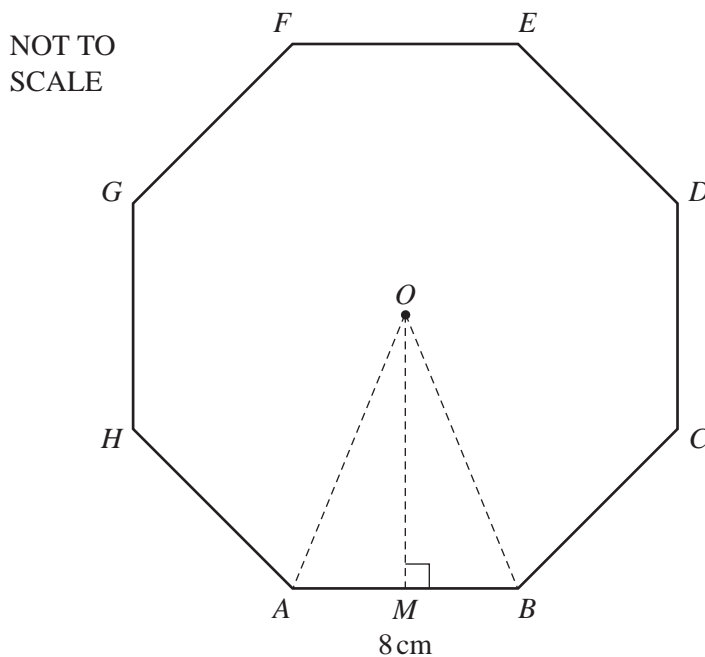

(i) Show that $OM = 9.66\text{ cm}$ correct to 3 significant figures.

Answer (c)(i)

[3]

- (ii) Calculate the area of the triangle AOB .

Answer(c)(ii) cm^2 [2]

- (iii) Calculate the area of the polygon.

Answer(c)(iii) cm^2 [1]

- (d) The polygon forms the cross-section of a box.
The box is a prism of height 12 cm.

Calculate the volume of the box.

Answer(d) cm^3 [1]

- (e) The box contains 200 toffees in the shape of cuboids, 3 cm by 2 cm by 2 cm.

Calculate

- (i) the total volume of the 200 toffees,

Answer(e)(i) cm^3 [2]

- (ii) the percentage of the volume of the box **not** filled by the toffees.

Answer(e)(ii) % [3]

For
Examiner's
Use

7

$$y = 9x - x^2.$$

(a) Complete the table of values for this equation.

x	0	1	2	3	4	5	6	7	8	9
y		8			20	20			8	0

[3]

(b) On the grid below, draw the graph of $y = 9x - x^2$ for $0 \leq x \leq 9$.

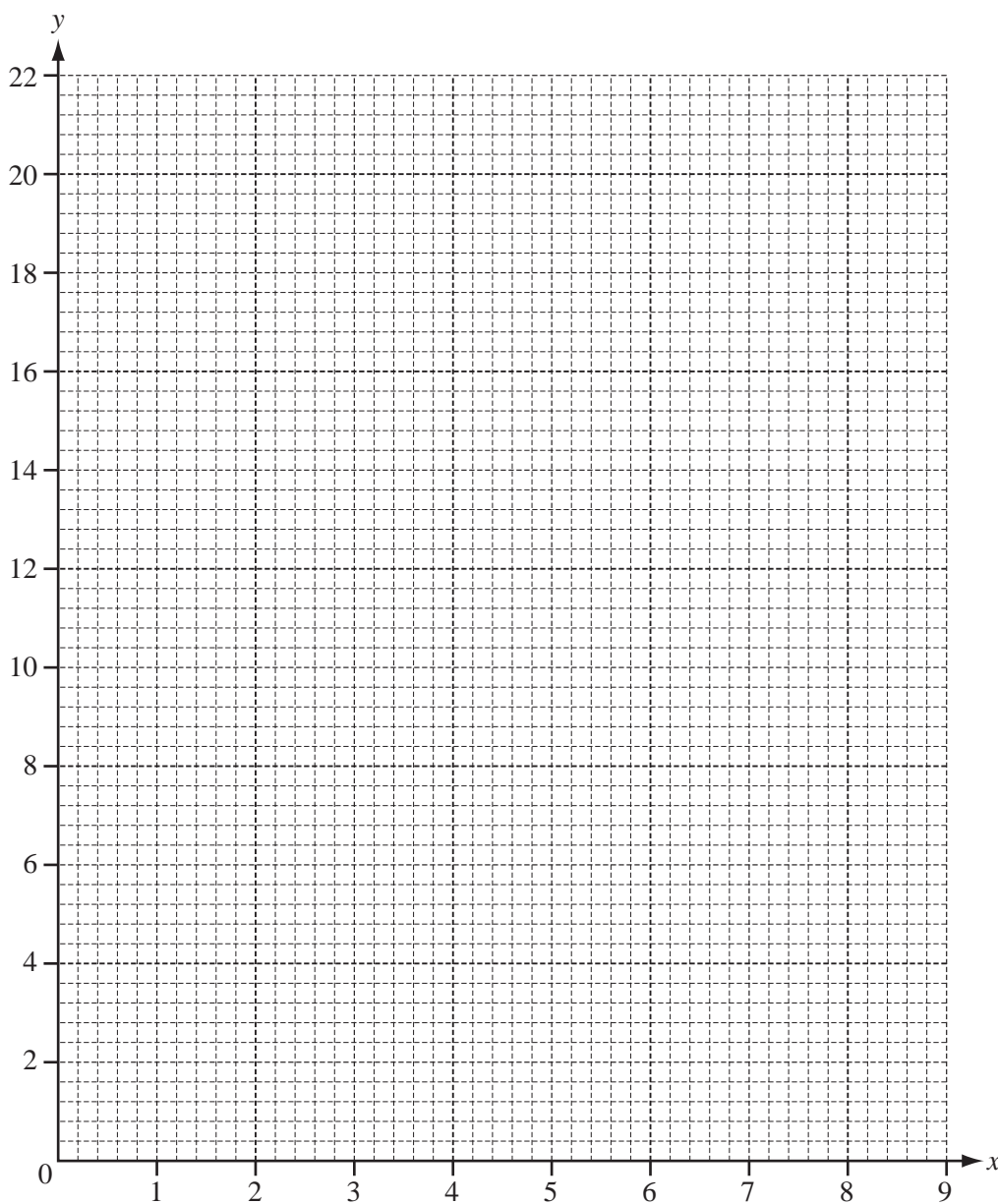

[4]

(c) Write down the values of x and y at the highest point of the curve.

For
Examiner's
Use

Answer(c) $x =$

$y =$ [2]

(d) (i) On the grid, draw the line $y = 6$ for $0 \leq x \leq 9$. [1]

(ii) Use this line to find the solutions of the equation

$$9x - x^2 = 6.$$

Give your answers correct to one decimal place.

Answer(d)(ii) $x =$ or $x =$ [2]

- 8 The table below shows the age and price of 20 used cars in a showroom.

Age (years)	6	5	4	5	4	5	1	6	3	8
Price (\$)	1800	7600	9500	2500	4100	3100	5600	4700	4800	7900
Age (years)	1	2	9	10	3	7	1	8	2	3
Price (\$)	6500	7000	1000	3800	1900	5200	3400	2100	4300	8200

For
Examiner's
Use

- (a) Use this information to complete the following table.

Age of cars (years)	Number of cars	Angle in a pie chart
1 to 3	8	144°
4 to 6	7	
7 or more		

[3]

- (b) (i) Complete the frequency table for the price, \$ x , of the cars.

Price (\$)	$0 \leq x < 2000$	$2000 \leq x < 4000$	$4000 \leq x < 6000$	$6000 \leq x < 8000$	$8000 \leq x < 10\ 000$
Frequency					

[2]

- (ii) Draw a histogram to show this information.

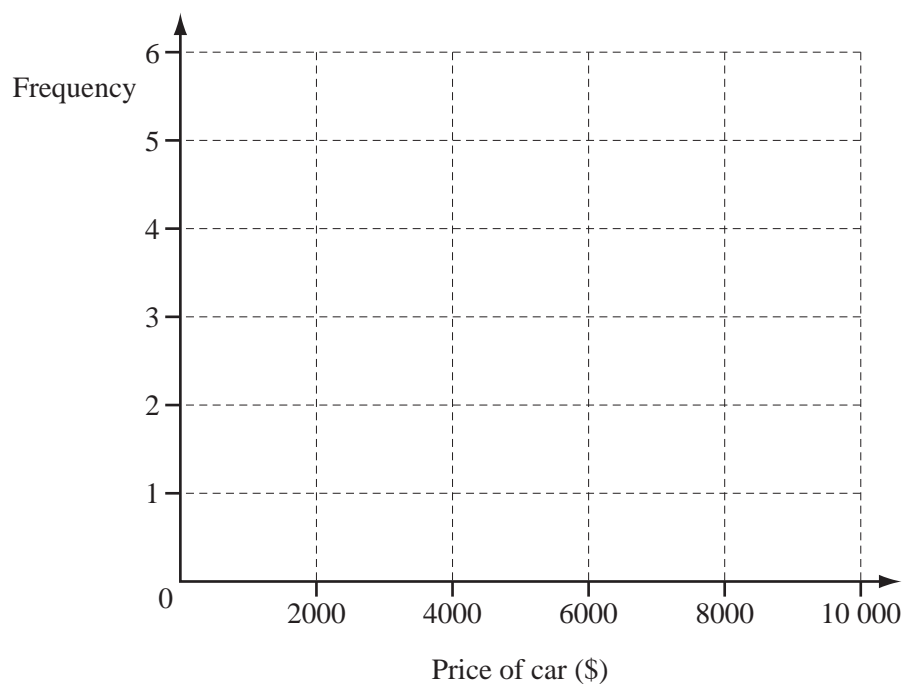

[2]

(c) (i) On the grid below complete the scatter diagram showing the age and price of each car.

The first 10 points from the original table have been plotted.

For
Examiner's
Use

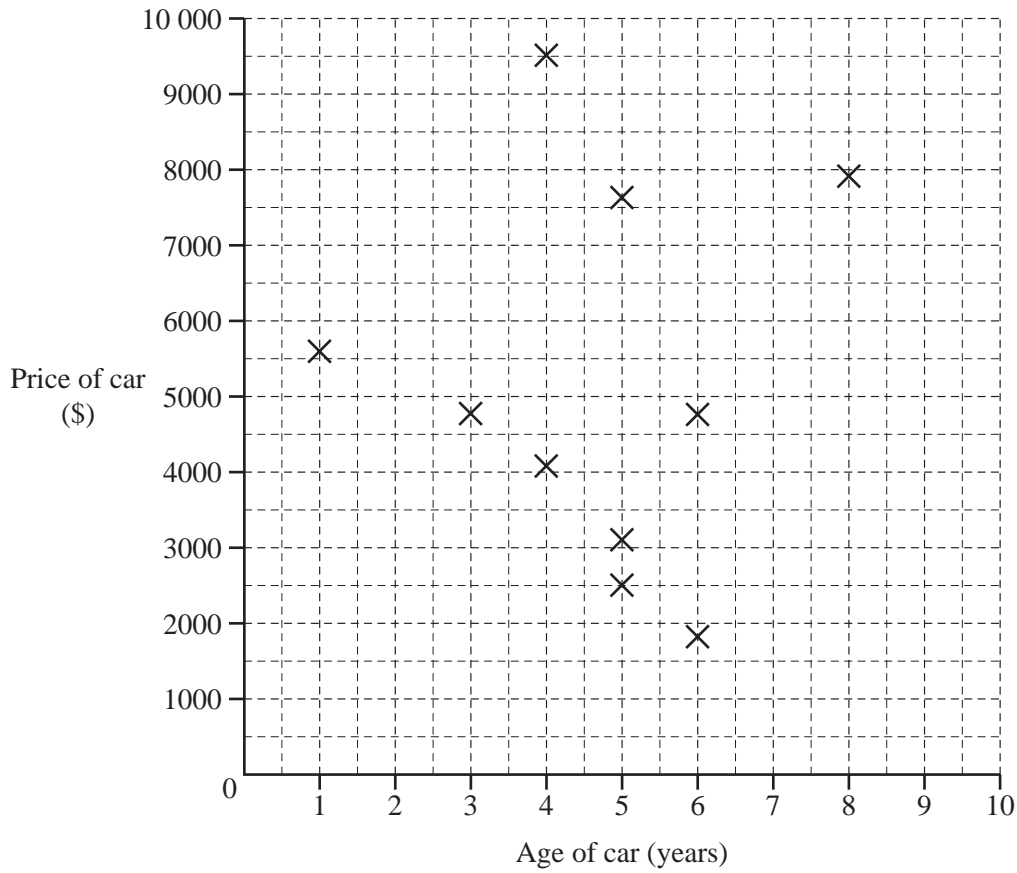

[3]

(ii) What correlation is there between the price of a car and its age?

Answer(c)(ii) [1]

(iii) A car is chosen at random.

Using your scatter diagram, find the probability that the car is more than 4 years old and the price is more than \$5000.

Answer(c)(iii) [2]

Question 9 is on the next page

9 (a) The first four terms of a sequence are 12, 7, 2, -3.

(i) Write down the next two terms of the sequence.

Answer(a)(i) and [2]

(ii) State the rule for finding the next term of the sequence.

Answer(a)(ii) [1]

(iii) Write down an expression for the n th term of this sequence.

Answer(a)(iii) [2]

(b) The first four terms of another sequence are -3, 2, 7, 12.

Write down an expression for the n th term of this sequence.

Answer(b) [2]

(c) Add together the expressions for the n th terms of both sequences.

Write your answer as simply as possible.

Answer(c) [1]

For
Examiner's
Use

Permission to reproduce items where third-party owned material protected by copyright is included has been sought and cleared where possible. Every reasonable effort has been made by the publisher (UCLES) to trace copyright holders, but if any items requiring clearance have unwittingly been included, the publisher will be pleased to make amends at the earliest possible opportunity.

University of Cambridge International Examinations is part of the Cambridge Assessment Group. Cambridge Assessment is the brand name of University of Cambridge Local Examinations Syndicate (UCLES), which is itself a department of the University of Cambridge.